

# 1001

## Wheel Dumpers



**WACKER  
NEUSON**  
*all it takes!*



### **The All-Round Dumper**

Fast, safe and easy transport even on the roughest of terrain and a discharge height of up to 1.56 m... the four-wheel dumper 1001 is particularly versatile, agile and extremely robust.

- High-tipping skip (1.56 m dumping height); maximum payload 1000 kg.
- Compact dimensions, optional narrow tires (990 mm machine width).
- Hydrostatic twin-lock four-wheel drive; continuously variable speed up to 14 km/h max.
- Large service and maintenance access.
- Clearly laid out instrument panel and wide, robust leg protection.

## 1001 Technical specifications

	High tip skip	Narrow
<b>Operating data</b>		
Payload kg	1,000	850
Shipping weight kg	1,215	1,150
Skip capacity level l	415	415
Skip capacity heaped l	525	525
Skip capacity water volume l	275	275
<b>Engine / Motor</b>		
Engine / Motor manufacturer	Yanmar	Yanmar
Engine / Motor type	3TNV76	3TNV76
Engine / Motor	Diesel	Diesel
Engine performance acc. to ISO 3046/1 kW	18.9	18.9
Emission standards stage	5	5
Displacement cm <sup>3</sup>	1,116	1,116
Engine RPM rpm	3000	
Travel speed km/h	14	14
Articulation angle °	33	33
Pendulum angle °	15	15
Turning radius mm	3,200	3,200
Gradeability %	45	45
Tires	10.00/75-15	6.00/16
L x W x H mm	3080 x 1180 x 2580	3080 x 990 x 2580
Steering pump	Axial piston pump	Axial piston pump
Flow rate l/min	84	84
Operating pressure bar	360	360
Duty pump	Gear pump	Gear pump
Flow rate l/min	25	25
Operating pressure bar	170	170
Fuel tank capacity l	15	15
Sound level (LwA) dB(A)	101	101

## 1001 Dimensions

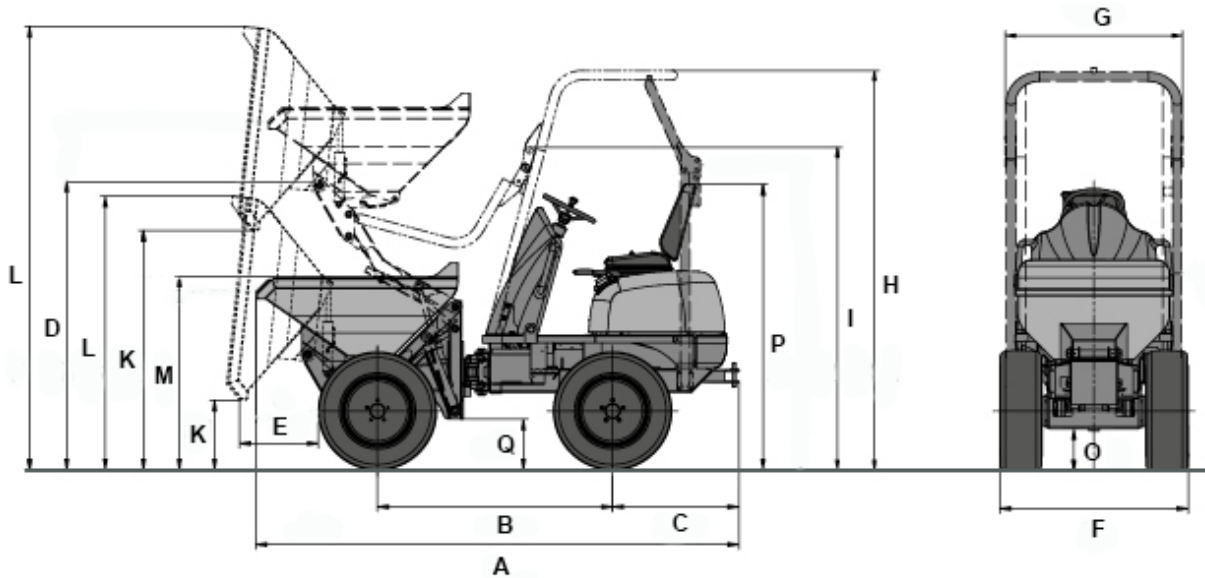

		High tip skip	Narrow
A	Overall length	3,080 mm	3,080 mm
B	Wheelbase	1,500 mm	1,500 mm
C	Rear overhang	810 mm	810 mm
D	Height	1,825 mm	1,825 mm
E	Dumping distance	510 mm	510 mm
F	Width vehicle	1,180 mm	990 mm
G	Skip width	990 mm	990 mm
H	Height ROPS	2,580 mm	2,580 mm
I	Height ROPS tipped	2,080 mm	2,080 mm
K	Dump height max.	465 mm	465 mm
K	Dump height max. High tip skip raised	1,560 mm	1,140 mm
L	Skip height tipped	1,770 mm	1,770 mm
L	Skip height High tip skip raised	2,860 mm	2,440 mm
M	Skip height	1,230 mm	1,230 mm
O	Ground clearance	270 mm	270 mm
P	Seat height	1,850 mm	1,850 mm
Q	Distance	327 mm	327 mm

Please note: that product availability can vary from country to country. It is possible that information / products may not be available in your country. More detailed information on engine power can be found in the operator's manual; the stated power may vary due to specific operating conditions. Subject to alterations and errors excepted. Applicable also to illustrations.  
Copyright © 2021 Wacker Neuson SE.